

MODERN
165567 30 1D
165568 40 1D
165569 60 2D
166501 30 1D M
166502 40 1D M
166503 60 2D M

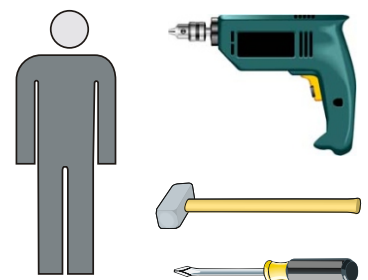

01.

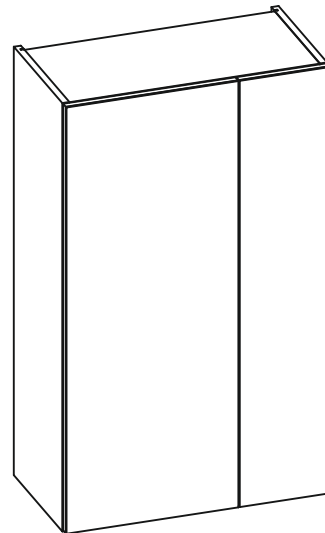
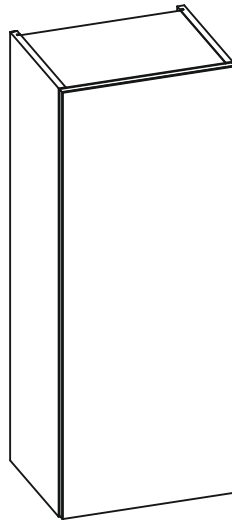
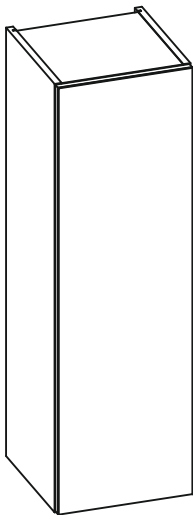
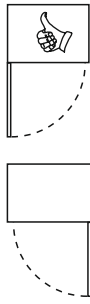

→ 03.

→ 04.

→ 05.

→ 06.

→ 02.

→ 03.

→ 04.

→ 05.

→ 06.

02.

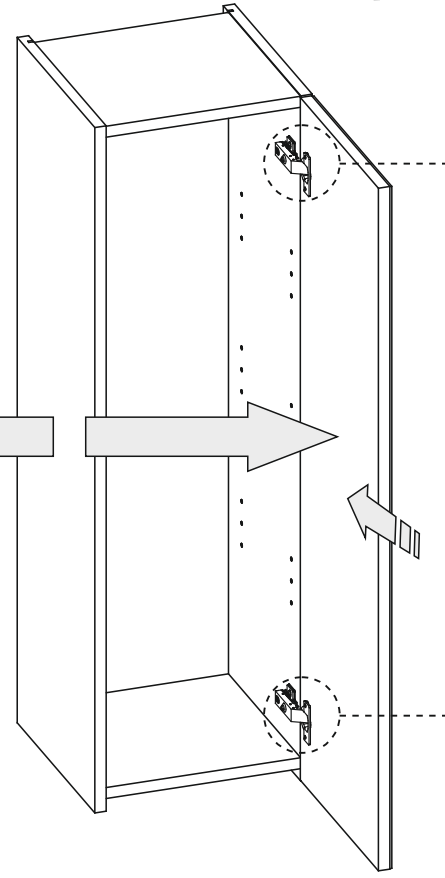
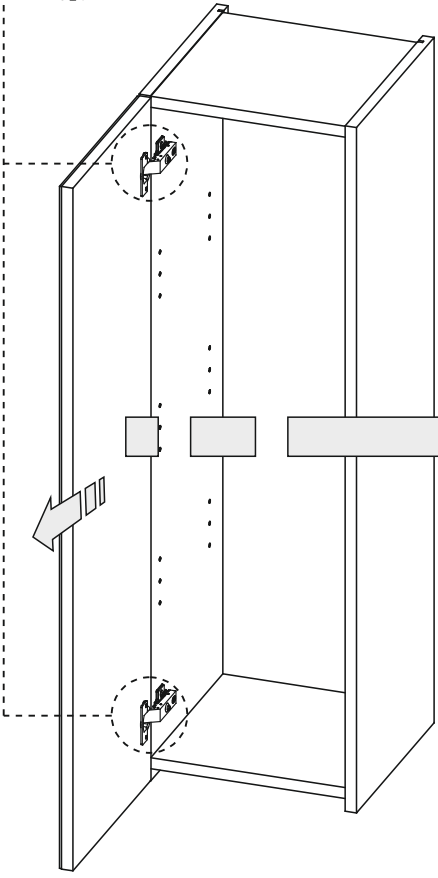
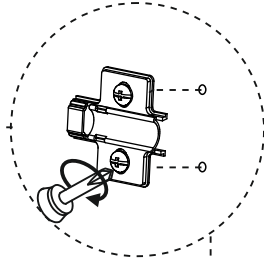
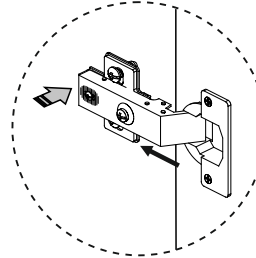
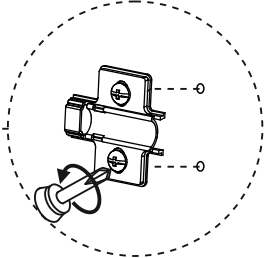
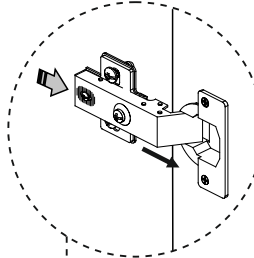

03.

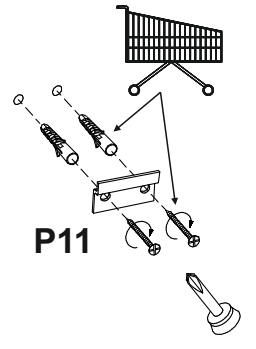
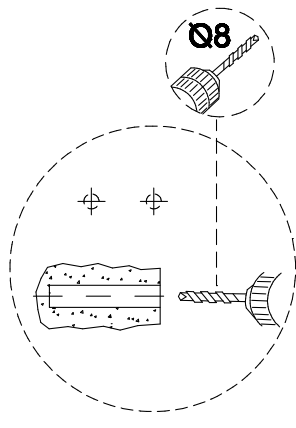
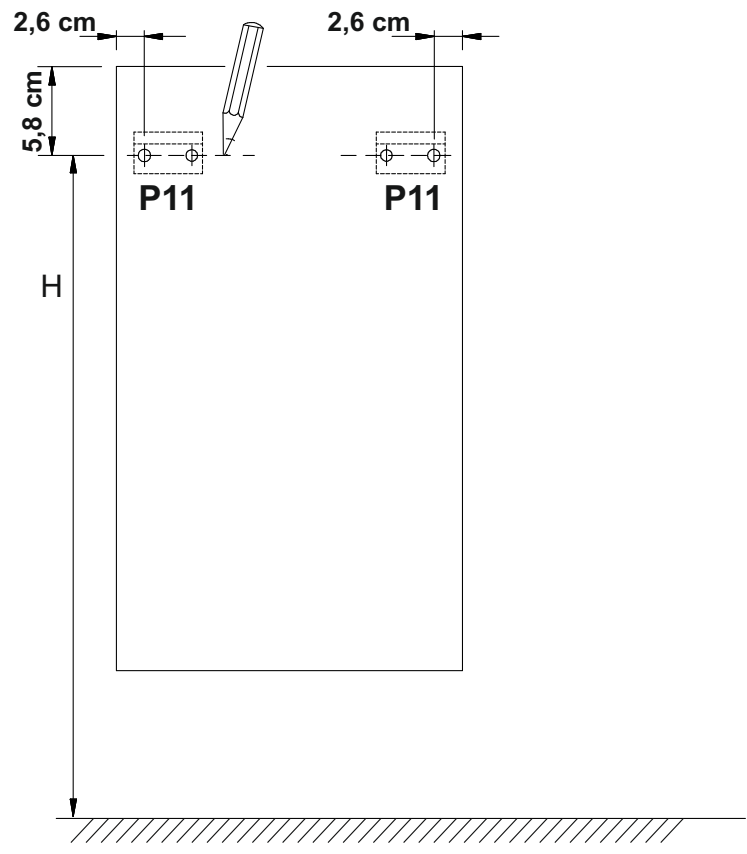
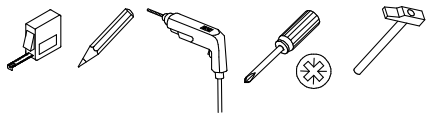

P11
x 2

04.

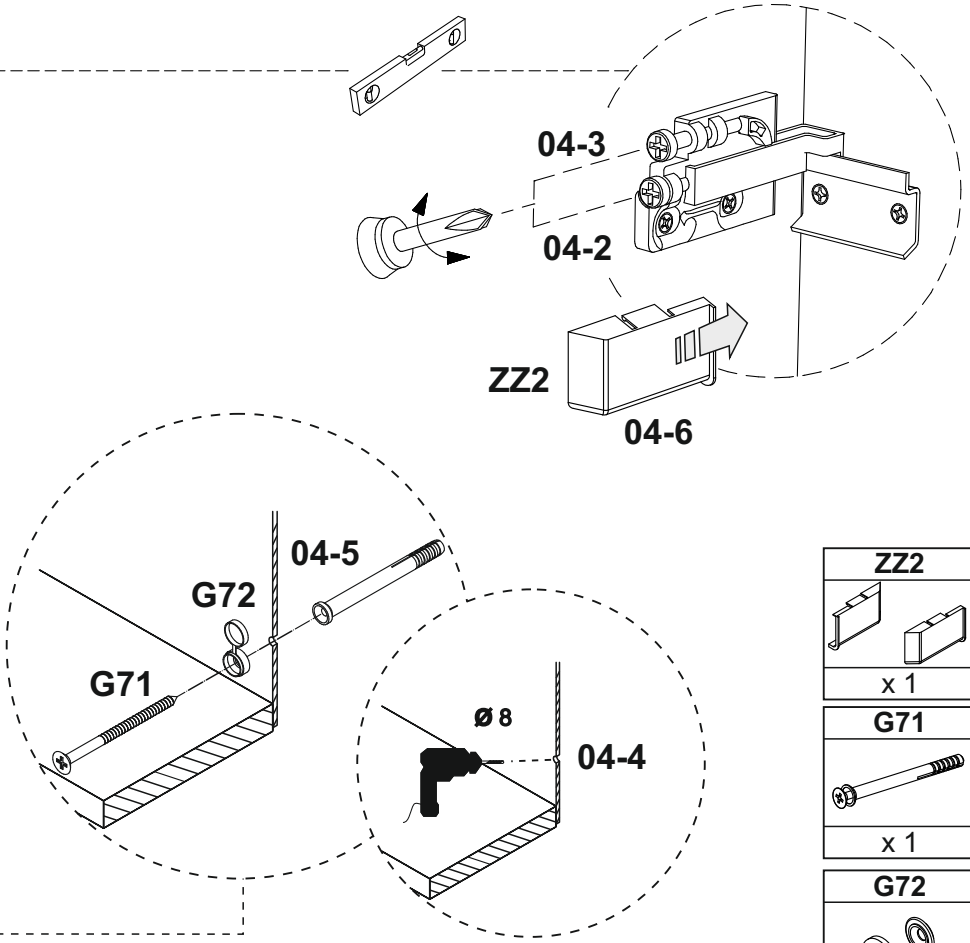
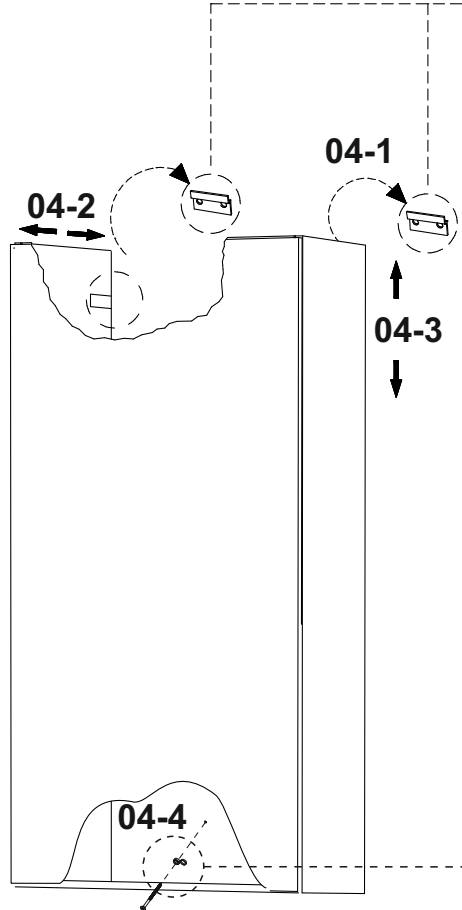
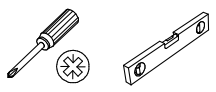

ZZ2
x 1
G71
x 1
G72
x 1

05.

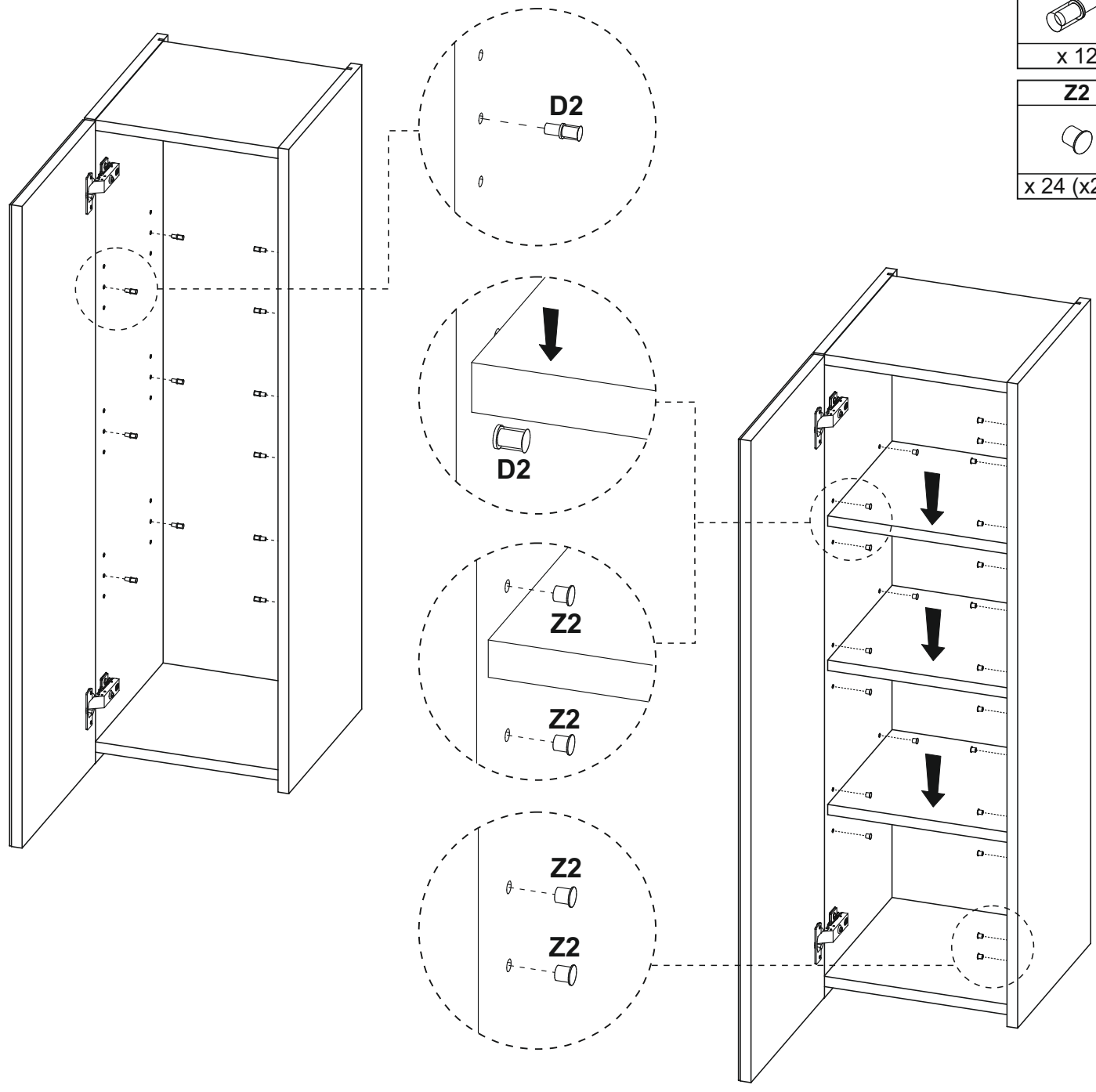

06.

